

PX1220S

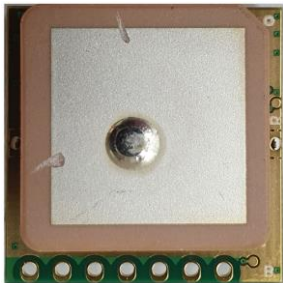

PX1220S

L1 Quad-Constellation Smart Antenna Module

Features

- 230 acquisition/tracking channels
- Support global GPS, Beidou, Galileo, GLONASS
- Supports regional QZSS, SBAS
- 16 million time-frequency hypothesis testing per sec
- -148dBm cold start sensitivity
- -165dBm tracking sensitivity
- 29 second cold start TTFF
- 3.5 second TTFF with AGPS
- 1 second hot start
- 2.0m CEP accuracy
- Multipath detection and suppression
- Jamming detection and mitigation
- Maximum update rate 25Hz
- RoHS compliant

The PX1220S is a compact all-in-one quad-constellation GNSS receiver module solution intended for a broad range of Original Equipment Manufacturer (OEM) products, where fast and easy system integration and minimal development risk is required.

The PX1220S GPS receiver's -165dBm tracking sensitivity allows continuous position coverage in nearly all application environments. Its high performance search engine is capable of testing 16,000,000 time-frequency hypotheses per second, offering industry-leading signal acquisition and TTFF speed.

The receiver is optimized for applications requiring high performance, low power, and low cost; suitable for a wide range of OEM configurations including navigation, tracking, and time synchronization products.

Applications

- Navigation
- Tracking
- Time synchronization

TECHNICAL SPECIFICATIONS

Receiver Type	L1 frequency, 230-channel Phoenix engine
Supported Satellites	GPS, Beidou, Galileo, GLONASS, QZSS
Augmentation System	QZSS, WAAS, EGNOS, MSAS, GAGAN
Accuracy	Position 2.0m CEP Velocity 0.1m/sec Time 10ns
Startup Time	1 / 28 / 29 second hot / warm / cold start under open sky average
Reacquisition	1s
Sensitivity	-148dBm cold-start -160dBm re-acquisition -165dBm tracking
Multi-path Mitigation	Advanced multi-path detection and suppression
A-GPS	7-day server-based AGPS Self-aided ephemeris estimation
Update Rate	1 / 2 / 4 / 5 / 8 / 10 / 20 / 25 Hz (default 1Hz)
Dynamics	4G (39.2m/sec ²)
Operational Limits	Altitude < 80,000m and velocity < 515m/s
Serial Interface	3.3V LVTTTL level
Protocol	NMEA-0183 V4.1, SkyTraq binary, 115200 baud, 8, N, 1
Datum	Default WGS-84, User definable
Input Voltage	3.3V DC +/-10%
Current Consumption	Acquisition 50mA @ 3.3V, Tracking 40mA @ 3.3V
Dimension	22mm L x 22mm W
Weight:	9g
Operating Temperature	-40°C ~ +85°C
Storage Temperature	-55 ~ +100°C
Humidity	5% ~ 95%

BLOCK DIAGRAM

PX1220S

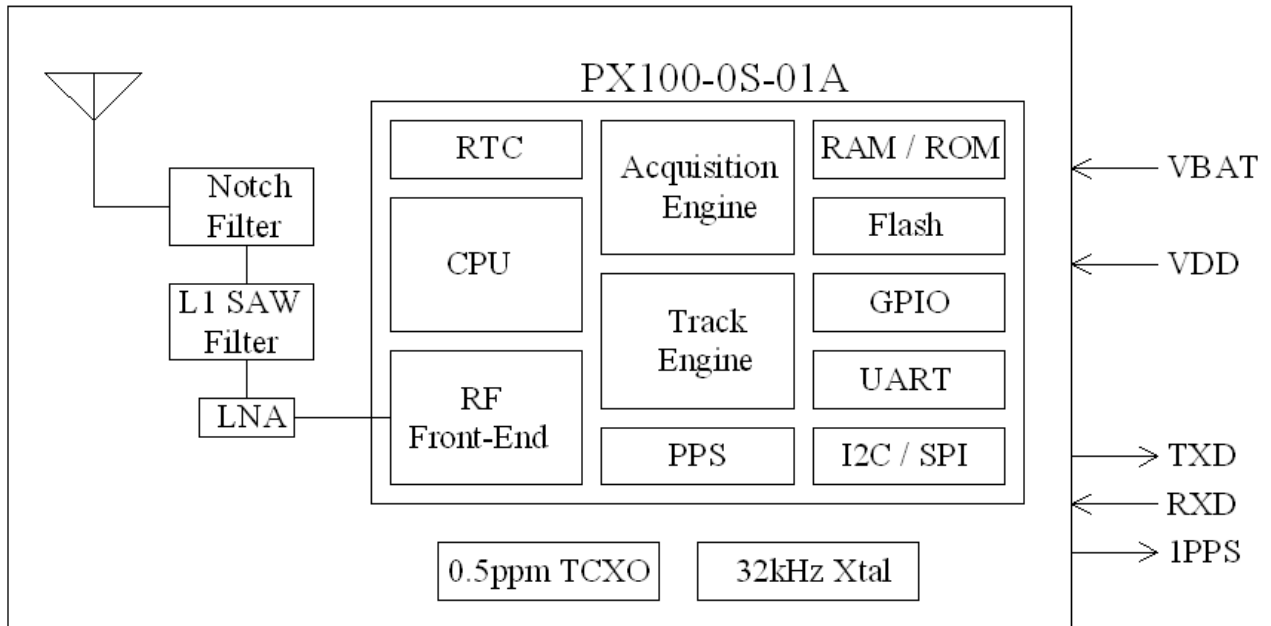

Module block schematic

PIN CONNECTION DESCRIPTION

Pin No.	Name	Description
1	RXD	UART serial data input, 3.3V LVTTTL. One full-duplex asynchronous serial UART port is implemented. This UART input is normally for sending commands or information to the receiver in SkyTraq binary protocol. In the idle condition, this pin should be driven HIGH. If the driving circuitry is powered independently of PX1220S, ensure that this pin is not driven to HIGH when primary power to PX1220S is removed, or a 10K-ohm series resistor can be added to minimize leakage current from application to the powered off module.
2	TXD	UART serial data output, 3.3V LVTTTL. One full-duplex asynchronous serial UART port is implemented. This UART output is normally used for sending position, time and velocity information from the receiver in NMEA-0183 format. When idle, this pin output HIGH.
3	GND	System ground
4	VDD	Main supply input, 3.0V ~ 3.6V
5	VBAT	Backup supply voltage for internal RTC and backup SRAM, 1.3V ~ 3.6V. VBAT must be applied whenever VDD is applied. This pin should be powered continuously to minimize the startup time. If VDD and VBAT are both removed, the receiver will be in factory default mode upon power up, all user configuration set is lost. For applications the does not care cold starting every time, this pin can be connected to VDD.
6	P1PPS	1 pulse per second time mark output
7	NC	Leave unconnected

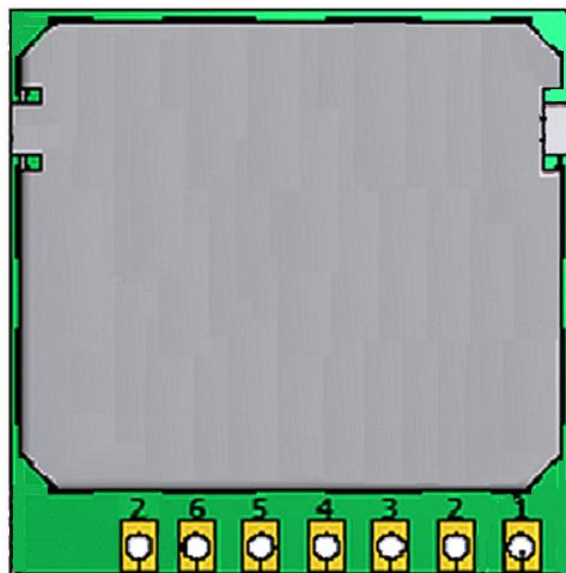

MECHANICAL DIMENSIONS

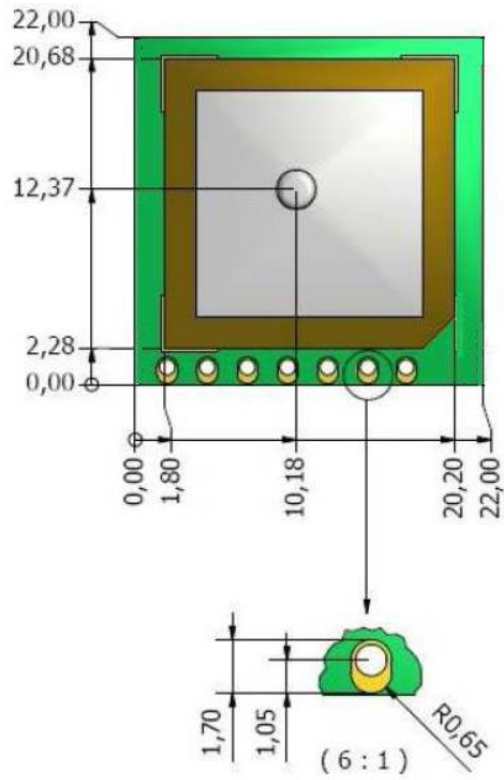
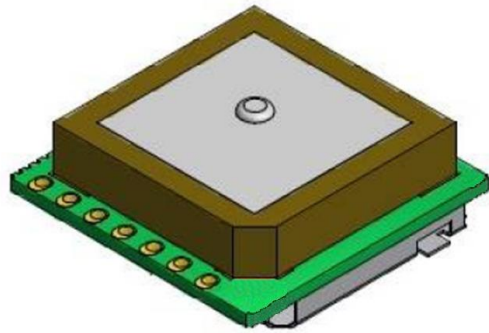
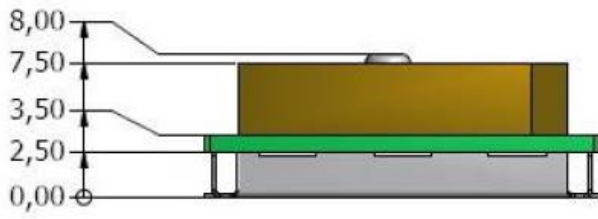

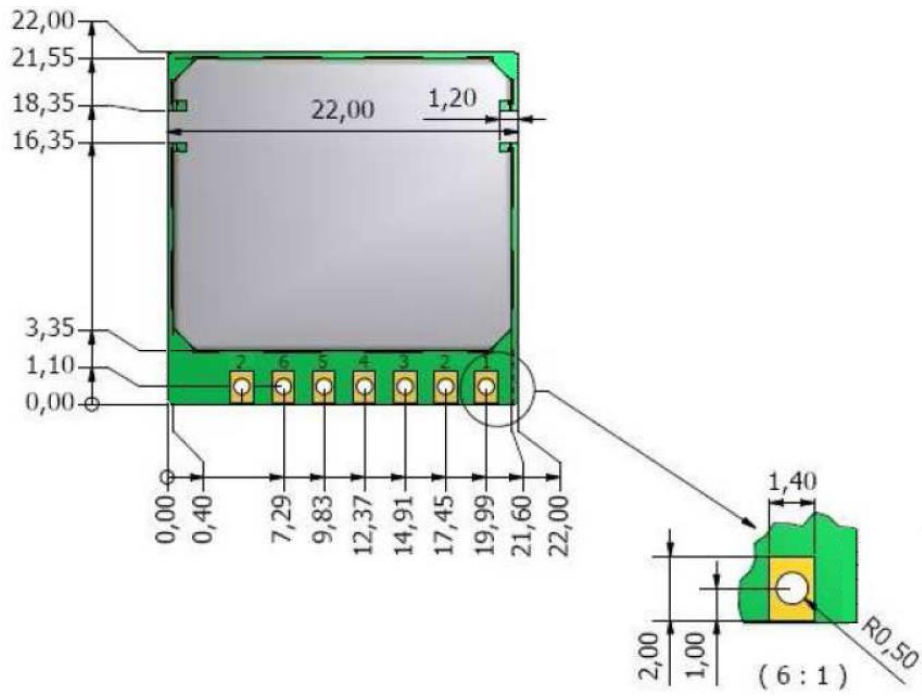

PCB MOUNTING

The PX1220S can be mounted on the application PCB using standard 2.54mm pitch 1x7 pin header. Two dummy soldering pads on the RF shield are used to fix the module to the application PCB. When soldering the 1x7 pin header, shorter the pins protruding on the side of the patch antenna the better.

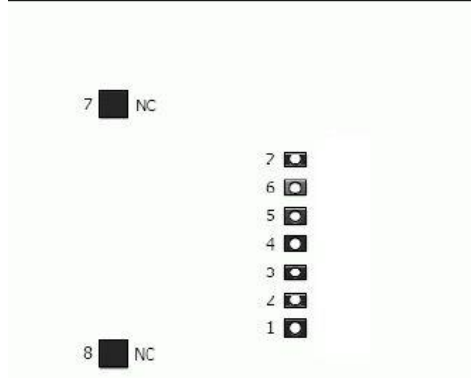
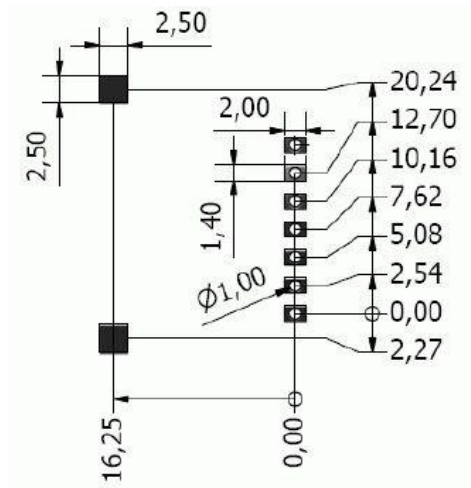

NMEA Output Description

The output protocol supports NMEA-0183 standard. The implemented messages include GGA, GLL, GSA, GSV, VTG, RMC, and ZDA messages. The NMEA message output has the following sentence structure:

\$aacc,c-c*hh<CR><LF>

The detail of the sentence structure is explained in Table 1.

Table 1: The NMEA sentence structure

character	HEX	Description
"\$"	24	Start of sentence.
Aacc		Address field. "aa" is the talker identifier. "ccc" identifies the sentence type.
","	2C	Field delimiter.
C-c		Data sentence block.
"*"	2A	Checksum delimiter.
Hh		Checksum field.
<CR><LF>	0D0A	Ending of sentence. (carriage return, line feed)

Table 2: Overview of SkyTraq receiver's NMEA messages

\$GPGGA	Time, position, and fix related data of the GPS receiver.
\$GNGLL	Position, time and fix status.
\$GNGSA	Used to represent the ID's of satellites which are used for position fix. When GPS satellites are used for position fix, \$GNGSA sentence is output with system ID 1. When GLONASS satellites are used for position fix, \$GNGSA sentence is output with system ID 2. When Galileo satellites are used for position fix, \$GNGSA sentence is output with system ID 3. When BDS satellites are used for position fix, \$GNGSA sentence is output with system ID 4.
\$GPGSV \$GLGSV \$GAGSV \$GBGSV	Satellite information about elevation, azimuth and CNR, \$GPGSV is used for GPS satellites, while \$GLGSV is used for GLONASS satellites, while \$GAGSV is used for GALILEO satellites, while \$GBGSV is used for BEIDOU satellites.
\$GNRMC	Time, date, position, course and speed data.
\$GNVTG	Course and speed relative to the ground.
\$GNZDA	UTC, day, month and year and time zone.

The formats of the supported NMEA messages are described as follows:

GGA – Global Positioning System Fix Data

Time, position and fix related data for a GPS receiver.

Structure:

\$GPGGA,hhmmss.sss,ddmm.mmmmm,a,dddmm.mmmmm,a,x,xx,x.x,x.x,M,x.x,M,x.x,xxxx*hh<CR><LF>
 1 2 3 4 5 6 7 8 9 10 11 12 13

Example:

\$GNGGA,052315.000,2447.09094,N,12100.52369,E,2,12,0.6,97.9,M,19.6,M,,0000*75<CR><LF>

Field	Name	Example	Description
1	UTC Time	025315.000	UTC of position in hhmmss.sss format, (000000.000 ~ 235959.999)
2	Latitude	2447.09094	Latitude in ddmm.mmmmm mformat Leading zeros transmitted
3	N/S Indicator	N	Latitude hemisphere indicator, 'N' = North, 'S' = South
4	Longitude	12100.52369	Longitude in dddmm.mmmmm format Leading zeros transmitted
5	E/W Indicator	E	Longitude hemisphere indicator, 'E' = East, 'W' = West
6	Quality Indicator	2	GPS quality indicator 0: position fix unavailable 1: valid position fix, SPS mode 2: valid position fix, differential GPS mode 3: GPS PPS Mode, fix valid 4: Real Time Kinematic. System used in RTK mode with fixed integers 5: Float RTK. Satellite system used in RTK mode., floating integers 6: Estimated (dead reckoning) Mode 7: Manual Input Mode 8: Simulator Mode
7	Satellites Used	12	Number of satellites in use, (00 ~ 12)
8	HDOP	0.6	Horizontal dilution of precision, (0.0 ~ 99.9)
9	Altitude	97.9	mean sea level (geoid), (-9999.9 ~ 17999.9)
10	Geoidal Separation	19.6	Geoidal separation in meters
11	Age pf Differential GPS data		Age of Differential GPS data NULL when DGPS not used
12	DGPS Station ID	0000	Differential reference station ID, 0000 ~ 1023
13	Checksum	75	

GLL – Latitude/Longitude

Latitude and longitude of current position, time, and status.

Structure:

\$GNGLL,ddmm.mmmmm,a,dddmm.mmmmm,a,hhmmss.sss,A,a*hh<CR><LF>
1 2 3 4 5 6 7 8

Example:

\$GNGLL,2447.09094,N, 12100.52369,E, 052315.000,A,D*4A<CR><LF>

Field	Name	Example	Description
1	Latitude	2447.09094	Latitude in ddmm.mmmmm format Leading zeros transmitted
2	N/S Indicator	N	Latitude hemisphere indicator 'N' = North 'S' = South
3	Longitude	12100.52369	Longitude in dddmm.mmmmm format Leading zeros transmitted
4	E/W Indicator	E	Longitude hemisphere indicator 'E' = East 'W' = West
5	UTC Time	052315.000	UTC time in hhmmss.sss format (000000.000 ~ 235959.999)
6	Status	A	Status, 'A' = Data valid, 'V' = Data not valid
7	Mode Indicator	D	Mode indicator 'A' = Autonomous mode 'D' = Differential mode 'E' = Estimated (dead reckoning) mode 'M' = Manual input mode 'S' = Simulator mode 'N' = Data not valid
8	Checksum	4A	

GSA – GNSS DOP and Active Satellites

GNSS receiver operating mode, satellites used in the navigation solution reported by the GGA or GNS sentence and DOP values.

Structure:

```
$GNGSA,A,x,xx,xx,xx,xx,xx,xx,xx,xx,xx,xx,xx,x.x,x.x,x.x,x*hh<CR><LF>
  1 2 3 3 3 3 3 3 3 3 3 3 3 4 5 6 7 8
```

Example:

```
$GNGSA,A,3,10,12,14,20,21,24,25,31,32,193,,,1.1,0.6,0.9,1*01<CR><LF>
$GNGSA,A,3,69,70,73,79,80,,,,,,,,,1.1,0.6,0.9,2*3C<CR><LF>
$GNGSA,A,3,01,02,03,06,09,10,14,16,21,22,26,,1.1,0.6,0.9,4<CR><LF>
```

Field	Name	Example	Description
1	Mode	A	Mode 'M' = Manual, forced to operate in 2D or 3D mode 'A' = Automatic, allowed to automatically switch 2D/3D
2	Mode	3	Fix type 1 = Fix not available 2 = 2D 3 = 3D
3	Satellite used 1~12	10, 12, 14, 20, 21, 24, 25, 31, 32, 193	01 ~ 32 are for GPS; 33 ~ 64 are for WAAS (PRN minus 87); 193 ~ 199 are for QZSS; 65 ~ 88 are for GLONASS (GL PRN) ; 01 ~ 36 are for GALILEO (GA PRN); 01 ~ 37 are for BDS (BD PRN). GPS, GLONASS, GALILEO and BDS satellites are differentiated by the GNSS system ID in table 3. Maximally 12 satellites are included in each GSA sentence.
4	PDOP	1.1	Position dilution of precision (0.0 to 99.9)
5	HDOP	0.6	Horizontal dilution of precision (0.0 to 99.9)
6	VDOP	0.9	Vertical dilution of precision (0.0 to 99.9)
7	GNSS System ID	1	GNSS system ID* 1 = GPS 2 = GLONASS 3 = GALILEO 4 = BDS 5 = IRNSS
8	Checksum	01	

*GNSS System ID identifies the GNSS system ID according to Table 3.

Table 3: GNSS Identification Table for GSA, GSV

System	System ID (Talker)	Signal ID	Signal Name
GPS	1 (GP)	0	All signals
		1	L1 C/A
		2	L1 P(Y)
		3	L1C
		4	L2 P(Y)
		5	L2C-M
		6	L2C-L
		7	L5-I
		8	L5-Q
GLONASS	2 (GL)	0	All signals
		1	G1 C/A
		2	G1P
		3	G2 C/A
		4	GLONASS (M) G2P
GALILEO	3 (GA)	0	All signals
		1	E5a
		2	E5b
		3	E5 a+b
		4	E6-A
		5	E6-BC
		6	L1-A
		7	L1-BC
BDS	4 (BD)	0	All signals
		1	B1
		5	B2A
		B	B2
		8	B3
		3	B1C
IRNSS	6 (GI)	0	All signals
		1	L5

GSV – GNSS Satellites in View

Number of satellites (SV) in view, satellite ID numbers, elevation, azimuth, and SNR value. Four satellites maximum per transmission.

Structure:

```
$GPGSV,x,x,xx,xx,xx,xxx,xx,...,xx,xx,xxx,xx,x *hh<CR><LF>
  1 2 3 4 5 6 7 4 5 6 7 8 9
```

Example:

```
$GPGSV,4,1,15,10,79,250,50,194,73,072,,193,69,127,45,25,64,114,46,1*67<CR><LF>
$GPGSV,4,2,15,20,54,175,45,32,44,334,46,41,39,242,43,12,36,055,46,1*68<CR><LF>
$GPGSV,4,3,15,31,32,256,45,14,25,310,39,24,15,049,38,21,07,191,35,1*61<CR><LF>
$GPGSV,4,4,15,15,04,106,18,29,03,144,,26,01,206,,1*56<CR><LF>
$GLGSV,2,1,06,80,77,332,44,69,55,098,49,70,46,347,43,73,29,221,45,1*79<CR><LF>
$GLGSV,2,2,06,79,25,026,42,71,01,325,,1*76<CR><LF>
$GBGSV,3,1,12,21,77,107,50,26,73,278,49,06,59,009,45,03,58,203,43,1*7D<CR><LF>
$GBGSV,3,2,12,16,58,002,47,07,55,180,,01,53,142,43,09,47,329,43,1*73<CR><LF>
$GBGSV,3,3,12,02,40,241,39,10,31,200,40,22,25,134,41,14,19,321,41,1*77<CR><LF>
```

Field	Name	Example	Description
1	Number of message	4	Total number of GSV messages to be transmitted (1-5)
2	Sequence number	1	Sequence number of current GSV message
3	Satellites in view	15	Total number of satellites in view (00 ~ 20)
4	Satellite ID	10	01 ~ 32 are for GPS; 33 ~ 64 are for WAAS (PRN minus 87); 193 ~ 199 are for QZSS; 65 ~ 88 are for GLONASS (GL PRN) ; 01 ~ 36 are for GALILEO (GA PRN); 01 ~ 37 are for BDS (BD PRN). GPS, GLONASS, GALILEO and BDS satellites are differentiated by the GNSS system ID in table 3. Maximally 4 satellites are included in each GSV sentence.
5	Elevation	79	Satellite elevation in degrees, (00 ~ 90)
6	Azimuth	250	Satellite azimuth angle in degrees, (000 ~ 359)
7	SNR	50	C/No in dB (00 ~ 99) Null when not tracking
8	GNSS System ID	1	Signal ID*
9	Checksum	67	

*GNSS Signal ID identifies the GNSS signal name according to Table 3.

RMC – Recommended Minimum Specific GNSS Data

Time, date, position, course and speed data provided by a GNSS navigation receiver.

Structure:

\$GNRMC,hhmmss.sss,A,dddmm.mmmmm,a,dddmm.mmmmm,a,x.x,x.x,ddmmyy,,,a,a*hh<CR><LF>
 1 2 3 4 5 6 7 8 9 101112

Example:

\$GNRMC,052315.000,A,2447.09094,N,12100.52369,E,000.0,169.9,261219,,,D,V*0F<CR><LF>

Field	Name	Example	Description
1	UTC time	052315.000	UTC time in hhmmss.sss format (000000.00 ~ 235959.999)
2	Status	A	Status 'V' = Navigation receiver warning 'A' = Data Valid
3	Latitude	2447.09094	Latitude in dddmm.mmmmm format Leading zeros transmitted
4	N/S indicator	N	Latitude hemisphere indicator 'N' = North 'S' = South
5	Longitude	12100.52369	Longitude in dddmm.mmmmm format Leading zeros transmitted
6	E/W Indicator	E	Longitude hemisphere indicator 'E' = East 'W' = West
7	Speed over ground	000.0	Speed over ground in knots (000.0 ~ 999.9)
8	Course over ground	169.9	Course over ground in degrees (000.0 ~ 359.9)
9	UTC Date	261219	UTC date of position fix, ddmmyy format
10	Mode indicator	D	Mode indicator 'A' = Autonomous mode 'D' = Differential mode 'E' = Estimated (dead reckoning) mode 'F' = Float RTK. Satellite system used in RTK mode, floating integers 'M' = Manual Input Mode 'N' = Data not valid 'P' = Precise 'R' = Real Time Kinematic. System used in RTK mode with fixed integers 'S' = Simulator Mode
11	Navigation status		Navigation status indicator according to IEC61108 requirement on 'Navigational (or Failure) warnings and status indicators'. 'S' = Safe 'C' = Caution 'U' = Unsafe 'V' = Navigation status not valid, equipment is not providing navigation status indicator.
12	checksum	0F	

VTG – Course Over Ground and Ground Speed

The actual course and speed relative to the ground.

Structure:

GNVTG,x.x,T,,M,x.x,N,x.x,K,a*hh<CR><LF>
1 2 3 4 5

Example:

\$GNVTG,169.9,T,,M,000.0,N,000.0,K,D*11<CR><LF>

Field	Name	Example	Description
1	Course	169.9	True course over ground in degrees (000.0 ~ 359.9)
2	Speed	000.0	Speed over ground in knots (000.0 ~ 999.9)
3	Speed	000.0	Speed over ground in kilometers per hour (000.0 ~ 1800.0)
4	Mode	D	Mode indicator 'A' = Autonomous mode 'D' = Differential mode 'E' = Estimated (dead reckoning) mode 'M' = Manual input mode 'N' = Data not valid 'P' = Precise 'S' = Simulator mode
5	Checksum	11	

ZDA – TIME AND DATE

UTC, day, month, year and local time zone

Structure:

\$GNZDA,hhmmss.sss,xx,xx,xxxx,xx,xx*hh<CR><LF>
1 2 3 4 5 6 7

Example:

\$GNZDA,052315.000,26,12,2019,00,00*45<CR><LF>

Field	Name	Example	Units	Description
1	UTC time	052315.000		UTC time in hhmmss.sss format (000000.00 ~ 235959.999)
2	UTC Day	26		UTC time: day (01 ~ 31)
3	UTC Month	12		UTC time: month (01 ~ 12)
4	UTC Year	209		UTC time: year (4 digit format)
5	Local zone hour	00		Local zone hours (00 ~ +/- 13)
6	Local zone minutes	00		Local zone minutes (00 ~59)
7	Checksum	45		Checksum

ORDERING INFORMATION

Model Name	Description
PX1220S	Flash Version L1 Quad-GNSS Smart Antenna Module
PX1220S-G	GPS-only version, NMEA 3.1 Output Compatible with SUP500R8 / SUP500F8
PX1220S-GG	GPS/GLONASS version, NMEA 3.1 Output
PX1220S-GB	GPS/Baidou version, NMEA 3.1 Output

Revision History

Revision	Date	Description
1	January 20, 2020	Initial release
2	April 17, 2020	Updated page-2 footnote
3	August 14, 2020	Removed page-2 footnote
4	August 19, 2020	Updated product image and current consumption
5	November 2, 2021	Updated Ordering Information
6	November 5, 2021	Updated Pin Connection Description

The information provided is believed to be accurate and reliable. These materials are provided to customers and may be used for informational purposes only. No responsibility is assumed for errors or omissions in these materials, or for its use. Changes to specification can occur at any time without notice.

These materials are provided "as is" without warranty of any kind, either expressed or implied, relating to sale and/or use including liability or warranties relating to fitness for a particular purpose, consequential or incidental damages, merchantability, or infringement of any patent, copyright or other intellectual property right. No warrant on the accuracy or completeness of the information, text, graphics or other items contained within these materials. No liability assumed for any special, indirect, incidental, or consequential damages, including without limitation, lost revenues or lost profits, which may result from the use of these materials.

The product is not intended for use in medical, life-support devices, or applications involving potential risk of death, personal injury, or severe property damage in case of failure of the product.